

SPL 170

Subwoofer

OWNER'S MANUAL AND INSTALLATION GUIDE

SOUNDSTREAM[®]
T E C H N O L O G I E S

SOUNDSTREAM TECHNOLOGIES

120 Blue Ravine Road • Folsom • California 95630 USA
tel 916.351.1288 fax 916.351.0414

(REV A, 7/22/97)

SOUNDSTREAM[®]
T E C H N O L O G I E S



CONGRATULATIONS! You have chosen a superior product for reproducing high "Sound Pressure Levels" in the car. This precision component, when properly installed, is capable of amazing output performance. SPL170 woofers are extremely high output speakers with performance made possible through outstanding design and exceptional quality in parts and construction.

Should your woofer ever require service or replacement, recording the information below for your own records will help protect your investment.

Model Number: _____

Serial Number: _____

Dealer's Name: _____

Date of Purchase: _____

Installation Shop: _____

Installation Date: _____

DESIGN FEATURES

- **New Custom Cone with Large Roll Polyether Surround** provides longer excursion and better control.
- **New Revolutionary Computer Numerically Controlled (CNC) Machined Aluminum Heat Sinks** conduct heat from the voice coil to increase power handling.
- **New Custom Designed Threaded Input Connectors** securely hold 8 gauge cable.
- **New Custom Non-Resonant Polypropylene Dust Dome** for added structural rigidity providing solid, well controlled performance.
- **Dual Voice Coil Inputs** provide increased flexibility in optimizing installations.
- **Heavy Cast Aluminum Silver Powder-Coated Basket** provides extra rigidity and damping.
- **Ultra-High Power Handling Four Layer Voice Coils with Kapton/Epoxy formers** increase power handling and performance.
- **Aerospace Grade Adhesives and Materials** insure longevity and high performance.
- **CNC Machined Magnet Plates** and pole piece precisely focus the magnetic energy for optimum performance.
- **High Emissivity Coatings** on all metal plates improve power handling.
- **Double Magnet Structures** for increased linear strength and throw.

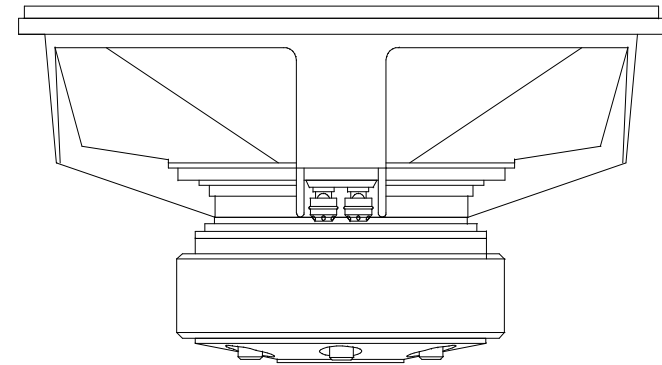

Vented (Continued)

- 4.5 ft³ @ 25 Hz (Two 4" x 16" ports) - *Designed for thunderous home theater bass. Use with 20 Hz high pass filter for very high power handling.*

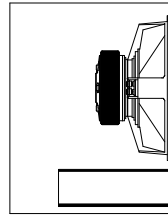
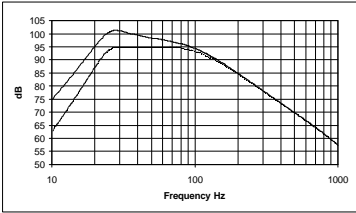

Vented (V)

Sealed Bandpass

- Rear = .87 ft³ sealed
- Front = 1.5 ft³ @ 75 Hz (Five 4" x 10" ports) - *Very high output in tiny enclosure. Great for SPL vehicles -- 102 dB with 2.83 volts input! Response limited to 45 to 100 Hz.*

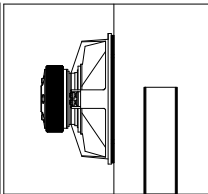
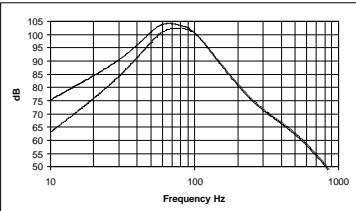

Sealed Bandpass (SBP)

- Rear = 1.2 ft³ sealed
- Front = 1.5 ft³ @ 62 Hz (Three 4" x 10" ports) - *High output with response to 35 Hz. Good enclosure for Rock and Rap music. 100 dB with 2.83 volts input.*

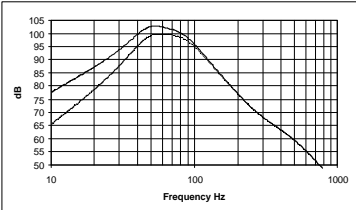

- Rear = 2 ft³ sealed
- Front = 1.5 ft³ @ 53

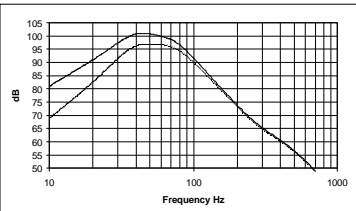

SPECIAL APPLICATION NOTE:

The three enclosures above have been designed with flexibility in mind. One single enclosure could be constructed to utilize all three response curves. An adjustable rear volume and port "covers" could allow use of all three

HEAT TRANSFER AND THE SPL170 -- 30 % BETTER COOLING

One of the major features of the SPL170 is its incorporation of materials and coatings to provide transfer and elimination of heat.

- When heat is produced in the voice coil, it must be removed. During speaker operation, heat from the voice coil is radiated and convected into the air and metal in the motor parts.
- The SPL170 includes unique aluminum plates attached to the top, pole and back plates to increase heat conduction from the steel parts. Additionally, the steel parts are black coated to increase their ability to absorb heat from the voice coil.

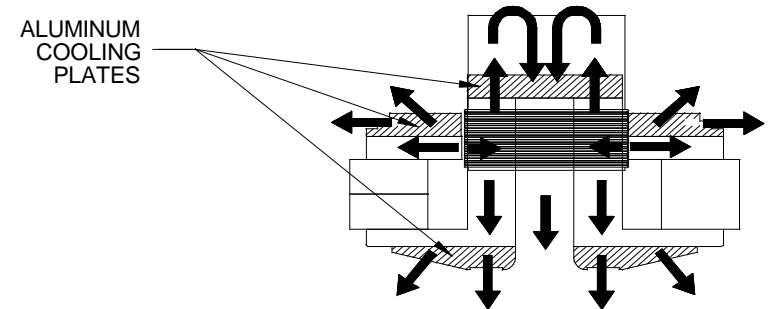

Tests show almost 30% improved heat transfer from the 170's voice coil. This produces a dual benefit to power handling and output:

1. More power handling before voice coil meltdown.
2. Reduced electrical resistance in the voice coil windings resulting in more current flow capability.

Footnote: The Physics of Heat Transfer

Heat energy, q, radiated between two bodies is determined by the formula:

$$q_{1-2} = \sigma \epsilon A_1 F_{1-2} (T_{14} - T_{24})$$

An important part of this equation is ϵ which is the "emissivity". The larger ϵ is, the more heat transfer takes place. ϵ is largest for a black surface (1.0). That's why wood stoves and car radiators are painted black.

SPECIFICATIONS & THIELE/SMALL PARAMETERS

Frequency Response (Hz)	25-500
Sensitivity (2.83v/1m)	96 dB
Impedance (nominal Z, ohms)	2/8
Rated Program Power, Watts	800
Fs (Hz)	26.2
Qts	.371
Qms	7.43
Qes	.390
Efficiency Bandwidth Product (Fs/Qes)	67.1
Vas (ft ³)	6.36
Vas (liters)	180
Vas (m ³)	.180
Cms (um/N)	160
DCR (ohms)	2.24
Levc (mH) @ 1 KHz	2.475
BL (Tesla m)	14.75
Sd (in ²)	131.0
Sd (m ²)	.089
Sd (cm ²)	890
X max; one way (linear mm)	9.5
X max; one way (peak mm)	27
Vd (linear cm ³)	847
Vd (peak cm ³)	2403
Vd (linear m ³)	0.000847
Vd (peak m ³)	0.002403
Mms (grams)	230
Magnet Assembly (oz)	358
Magnet Weight (oz)	118
Vf (volume of frame. in ³)	385

SUGGESTED ENCLOSURES

Infinite Baffle

- Excellent performance for all types of music at moderate levels

Sealed

- 1.0 ft³ - *Great all around performing box. Very small enclosure. Good for Rock and Rap.*

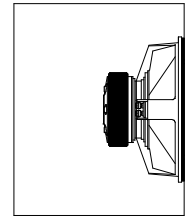
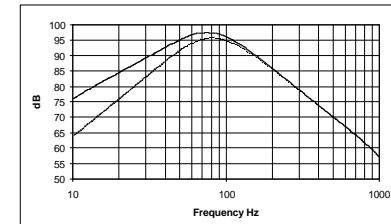

Sealed

- 2.0 ft³ - *Slightly deeper response. Strong bass at 20 Hz in car. Good for Rock, Rap and Jazz.*

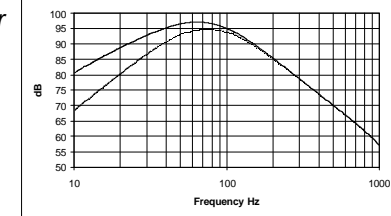

Vented

- 2.0 ft³ @ 40 Hz (Two 4" x 13.5" ports) - *Very strong output from 40 Hz to 100 Hz. Suggest using high pass filter near 40 Hz for maximum power handling and output. Very small enclosure.*

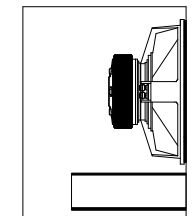
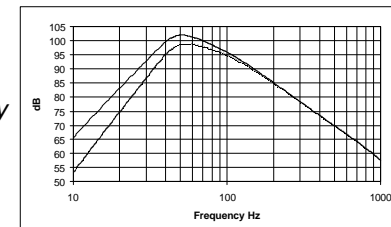

Vented (V)

- 3.2 ft³ @ 28 Hz (Two 4" x 18.5" ports) - *Very strong output to 30 Hz. Good for home theater or accurate bass in*

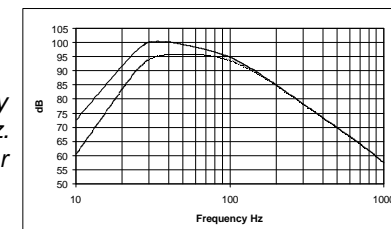

BUILDING THE ENCLOSURE

- Determine the dimensions of your enclosure.
- Be certain the box you have designed will fit into the location you have chosen. Sometimes making a cardboard box with the same outside dimensions is helpful.
- Use 3/4 inch thick Medium Density Fiberboard (MDF) or High Density Particleboard. It is preferable to cut the wood with a table saw to ensure straight, even joints. If a table saw is not available, a circular saw is acceptable.
- Use a "T" square to verify precise right angle gluing.
- Use a high quality wood glue and air nails or wood screws to assemble the enclosure. Elmer's® woodworker's glue and Weldwood® work well. To guarantee an airtight box, seal each inside joint with silicone sealant.
- For Sealed Enclosures, stuff the chamber with 50-75% filling (approximately 1.5 pounds per cubic foot) of fiberglass insulation or Dacron®.
- For Vented Enclosures, staple 1 inch thick fiberglass insulation or Dacron to all walls of the enclosure except the baffle to which the woofer is mounted.
- Use the supplied gasket to seal the woofer in the enclosure and eight(8) wood screws or T-nuts and bolts. Progressively tighten each of the bolts or screws to prevent warping the woofer frame.
- Use slide-on connectors to attach speaker wires. Do not solder wires to the

SUGGESTED ENCLOSURES

The following designs include a variety of enclosure sizes and types. Each design has two frequency response curves; one showing predicted "In-Car" response, and the other showing "Half-Space Anechoic" (out-of-car) frequency response. The performance difference between the two curves is a result of the natural acoustics of an "average" automotive environment. This "average" transfer function is only an approximation of what you may expect to see in your car. Every car is different. Each curve was generated using 2.83 Volts across both voice coils in parallel and measured at 1 meter. Also, each frequency response curve includes a 12 dB/octave low pass at 100 Hz for sealed and vented enclosures and 200 Hz for bandpass enclosures. The response curves can help you visualize relative performance differences between designs. Read through the descriptions given for each enclosure and select the one that suits your needs.

Remember: all suggested enclosure volumes are Net, and DO NOT include woofer, port, and bracing displacement!

SELECTING AN ENCLOSURE

There are several different enclosure designs for different applications. The SPL subwoofers work very well in all the following enclosure designs. It is up to you to select the specific enclosure that will work the best for your particular application.

Infinite Baffle

Infinite baffle is the simplest type of subwoofer installation. In this type of installation, the woofer(s) is mounted to a baffle which is then mounted to either the rear deck or back seat of the vehicle. The best results are achieved when the trunk area is virtually airtight and isolated from the passenger compartment.

Pros

- Excellent low frequency extension
- Excellent transient response
- Uses almost no trunk space

Cons

- Lower power handling
- Low to medium efficiency

Sealed Enclosure

Sealed enclosures are relatively simple to build and install, as all that is required is an airtight box. The larger the sealed enclosure, the more the performance resembles that of an infinite baffle installation.

Pros

- Very good low frequency extension
- Very good transient response
- High power handling

Cons

- Medium efficiency

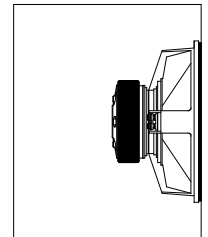

Sealed

Vented Enclosure

Vented enclosures use a sealed enclosure with a vent or port in the box which is tuned to resonate at a specific frequency.

Pros

- Good low frequency extension down to the tuning frequency
- High power handling down to the tuning frequency
- Higher output than sealed enclosures

Cons

- Low power handling below the tuning frequency
- Almost no output below the tuning frequency

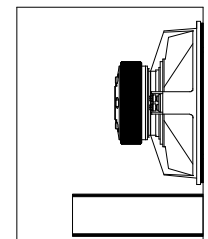

Vented (V)

Sealed Bandpass Enclosure

Sealed bandpass enclosures enclose both sides of the woofer(s). An airtight enclosure is built around the front and back of the woofer and one chamber is ported to a specific frequency.

Pros

- High power handling within the operating frequencies
- Very high output within the range of the operating frequencies

Cons

- Low power handling beyond the tuning frequency
- Poor to moderate transient response
- Poor low frequency extension

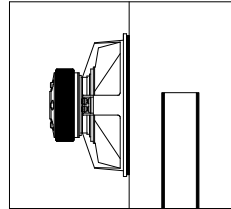

Sealed Bandpass (SBP)

CALCULATING (NET) INTERNAL ENCLOSURE VOLUMES

When constructing any type of enclosure, you must be aware that the outside dimensions DO NOT represent the true (Net) volume inside. Such things as woofers, ports, thickness of enclosure material, dividing walls, and any internal bracing will reduce the total amount of the actual air space available. The following worksheet has been designed to provide you with the necessary steps to accurately calculate the absolute (Net) internal volume of any given enclosure.

Calculating Cylindrical Port Volume

1. Measure the outside diameter of the port and divide by 2 for the radius.
2. Square the radius and multiply by 3.14 (π) to arrive at outside port area.
3. Multiply the area by the length of the port *inside* the enclosure for the port volume.

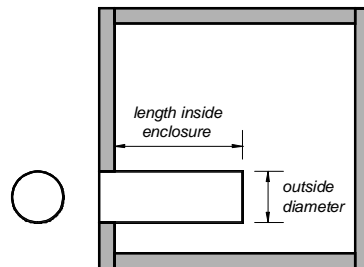

ENCLOSURE VOLUME FLOWCHART

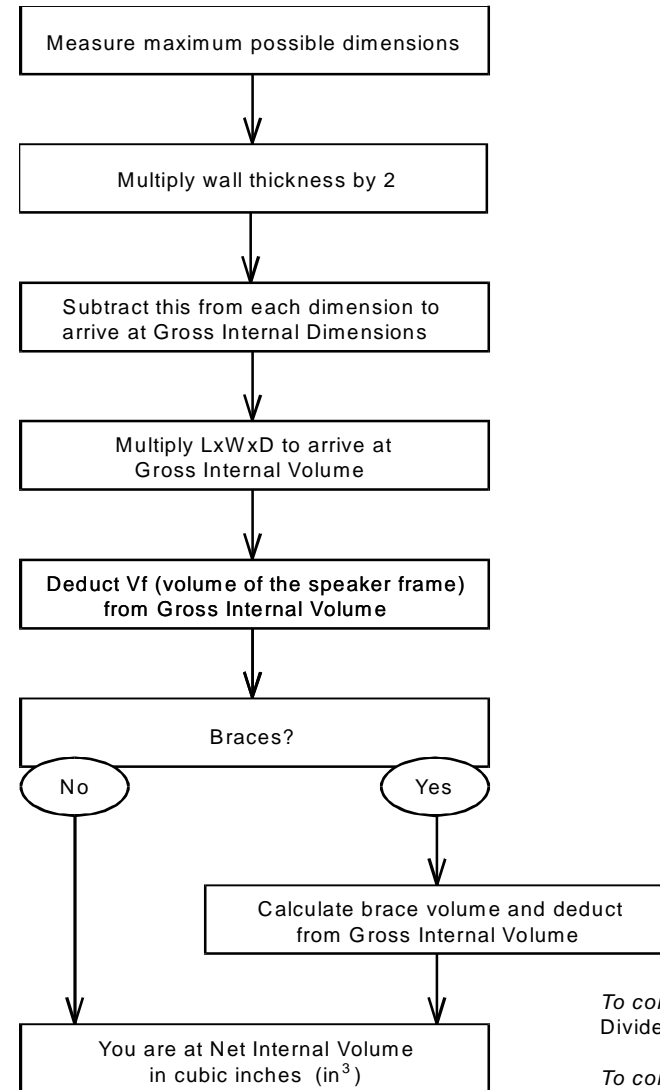

To convert to LITERS:
Divide in^3 by 61.03

To convert to CUBIC FEET:
Divide in^3 by 1728